

| | | |
|--------------|---|---------------------|
| V_{DRM} | = | 4200 V |
| $I_{T(AV)M}$ | = | 4420 A |
| $I_{T(RMS)}$ | = | 6950 A |
| I_{TSM} | = | $64.5 \cdot 10^3$ A |
| V_{T0} | = | 0.973 V |
| r_T | = | 0.126 m Ω |

Phase Control Thyristor

5STP 38Q4200

Doc. No. 5SYA1051-04 May. 20

- Patented free-floating silicon technology
- Low on-state and switching losses
- Designed for traction, energy and industrial applications
- Optimum power handling capability
- Interdigitated amplifying gate

Blocking

Maximum rated values ¹⁾

| Parameter | Symbol | Conditions | 5STP 38Q4200 | Unit |
|--|--------------------------|--|--------------|------------|
| Max repetitive peak forward and reverse blocking voltage | V_{DRM} , V_{RRM} | $f = 50$ Hz, $t_p = 10$ ms, $T_{vj} = 5 \dots 125$ °C, Note 1 | 4200 | V |
| Critical rate of rise of commutating voltage | dv/dt_{crit} | Exp. to $0.67 \cdot V_{DRM}$, $T_{vj} = 125$ °C | 2000 | V/ μ s |

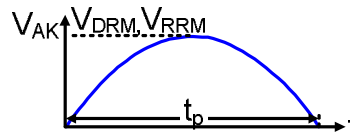

Characteristic values

| Parameter | Symbol | Conditions | min | typ | max | Unit |
|-------------------------|-----------|-------------------------------|-----|-----|-----|------|
| Forward leakage current | I_{DRM} | V_{DRM} , $T_{vj} = 125$ °C | | | 400 | mA |
| Reverse leakage current | I_{RRM} | V_{RRM} , $T_{vj} = 125$ °C | | | 400 | mA |

Note 1: Voltage de-rating factor of 0.11% per °C is applicable for T_{vj} below +5 °C.

Mechanical data

Maximum rated values ¹⁾

| Parameter | Symbol | Conditions | min | typ | max | Unit |
|----------------|--------|------------------|-----|-----|-----|------------------|
| Mounting force | F_M | | 81 | 90 | 108 | kN |
| Acceleration | a | Device unclamped | | | 50 | m/s ² |
| Acceleration | a | Device clamped | | | 100 | m/s ² |

Characteristic values

| Parameter | Symbol | Conditions | min | typ | max | Unit |
|---------------------------|--------|------------------------------|-------|-----|-------|------|
| Weight | m | | | | 2.1 | kg |
| Housing thickness | H | $F_M = 90$ kN, $T_a = 25$ °C | 26.09 | | 26.54 | mm |
| Surface creepage distance | D_s | | 36 | | | mm |
| Air strike distance | D_a | | 15 | | | mm |

1) Maximum rated values indicate limits beyond which damage to the device may occur

ABB Power Grids Switzerland Ltd, Semiconductors reserves the right to change specifications without notice.



On-state

Maximum rated values ¹⁾

| Parameter | Symbol | Conditions | min | typ | max | Unit |
|-----------------------------------|--------------|--|-----|-----|-------------------|--------|
| Average on-state current | $I_{T(AV)M}$ | Half sine wave, $T_c = 70\text{ °C}$ | | | 4420 | A |
| RMS on-state current | $I_{T(RMS)}$ | | | | 6950 | A |
| Peak non-repetitive surge current | I_{TSM} | $t_p = 10\text{ ms}$, $T_{vj} = 125\text{ °C}$, sine half wave, | | | $64.5 \cdot 10^3$ | A |
| Limiting load integral | I^2t | $V_D = V_R = 0\text{ V}$, after surge | | | $20.8 \cdot 10^6$ | A^2s |
| Peak non-repetitive surge current | I_{TSM} | $t_p = 10\text{ ms}$, $T_{vj} = 125\text{ °C}$, sine half wave, | | | $51.0 \cdot 10^3$ | A |
| Limiting load integral | I^2t | $V_R = 0.6 \cdot V_{RRM}$, after surge | | | $13.0 \cdot 10^6$ | A^2s |

Characteristic values

| Parameter | Symbol | Conditions | min | typ | max | Unit |
|-------------------|------------|--|-----|------|-------|-----------|
| On-state voltage | V_T | $I_T = 3000\text{ A}$, $T_{vj} = 125\text{ °C}$ | | 1.24 | 1.35 | V |
| Threshold voltage | $V_{(TO)}$ | $I_T = 2500\text{ A} - 7500\text{ A}$, $T_{vj} = 125\text{ °C}$ | | | 0.973 | V |
| Slope resistance | r_T | | | | 0.126 | $m\Omega$ |
| Holding current | I_H | $T_{vj} = 25\text{ °C}$ | | | 100 | mA |
| | | $T_{vj} = 125\text{ °C}$ | | | 75 | mA |
| Latching current | I_L | $T_{vj} = 25\text{ °C}$ | | | 500 | mA |
| | | $T_{vj} = 125\text{ °C}$ | | | 350 | mA |

Switching

Maximum rated values ¹⁾

| Parameter | Symbol | Conditions | min | typ | max | Unit |
|---|----------------|---|-----|-----|------|-----------|
| Critical rate of rise of on-state current | di/dt_{crit} | $T_{vj} = 125\text{ °C}$, $I_T = 5000\text{ A}$, $V_D \leq 0.67 \cdot V_{DRM}$, $I_{GM} = 2\text{ A}$, $t_r = 0.5\text{ }\mu s$ | | | 250 | $A/\mu s$ |
| | | Cont. $f = 50\text{ Hz}$ | | | 1000 | $A/\mu s$ |
| Circuit-commutated turn-off time | t_q | $T_{vj} = 125\text{ °C}$, $I_T = 2000\text{ A}$, $V_R = 200\text{ V}$, $di_T/dt = -1.5\text{ A}/\mu s$, $V_D \leq 0.67 \cdot V_{DRM}$, $dV_D/dt = 20\text{ V}/\mu s$ | | | 600 | μs |

Characteristic values

| Parameter | Symbol | Conditions | min | typ | max | Unit |
|--------------------------|----------|--|------|------|------|----------|
| Reverse recovery charge | Q_{rr} | $T_{vj} = 125\text{ °C}$, $I_T = 2000\text{ A}$, $V_R = 200\text{ V}$, $di_T/dt = -1.5\text{ A}/\mu s$ | 2500 | 4300 | 5000 | μAs |
| Reverse recovery current | I_{RM} | | 45 | 76 | 95 | A |
| Gate turn-on delay time | t_{gd} | $T_{vj} = 25\text{ °C}$, $V_D = 0.4 \cdot V_{RM}$, $I_{GM} = 2\text{ A}$, $t_r = 0.5\text{ }\mu s$ | | | 3 | μs |

Triggering

Maximum rated values ¹⁾

| Parameter | Symbol | Conditions | min | typ | max | Unit |
|---------------------------|--------------------|------------|------------|-----|-----|------|
| Peak forward gate voltage | V _{FGM} | | | | 12 | V |
| Peak forward gate current | I _{FGM} | | | | 10 | A |
| Peak reverse gate voltage | V _{RGM} | | | | 10 | V |
| Average gate power loss | P _{G(AV)} | | see Fig. 7 | | | W |

Characteristic values

| Parameter | Symbol | Conditions | min | typ | max | Unit |
|--------------------------|-----------------|---|-----|-----|-----|------|
| Gate-trigger voltage | V _{GT} | T _{vj} = 25 °C | | | 2.6 | V |
| Gate-trigger current | I _{GT} | T _{vj} = 25 °C | | | 400 | mA |
| Gate non-trigger voltage | V _{GD} | V _D = 0.4·V _{DRM} , T _{vjmax} = 125 °C | | | 0.3 | V |
| Gate non-trigger current | I _{GD} | V _D = 0.4·V _{DRM} , T _{vjmax} = 125 °C | | | 10 | mA |

Thermal

Maximum rated values ¹⁾

| Parameter | Symbol | Conditions | min | typ | max | Unit |
|--------------------------------------|------------------|------------|-----|-----|-----|------|
| Operating junction temperature range | T _{vj} | | | | 125 | °C |
| Storage temperature range | T _{stg} | | -40 | | 140 | °C |

Characteristic values

| Parameter | Symbol | Conditions | min | typ | max | Unit |
|-------------------------------------|-----------------------|--|-----|-----|-----|------|
| Thermal resistance junction to case | R _{th(j-c)} | Double-side cooled F _m = 81... 108 kN | | | 5 | K/kW |
| | R _{th(j-c)A} | Anode-side cooled F _m = 81... 108 kN | | | 10 | K/kW |
| | R _{th(j-c)C} | Cathode-side cooled F _m = 81... 108 kN | | | 10 | K/kW |
| Thermal resistance case to heatsink | R _{th(c-h)} | Double-side cooled F _m = 81... 108 kN | | | 1 | K/kW |
| | R _{th(c-h)} | Single-side cooled F _m = 81... 108 kN | | | 2 | K/kW |

Analytical function for transient thermal impedance:

$$Z_{th(j-c)}(t) = \sum_{i=1}^n R_i (1 - e^{-t/\tau_i})$$

| i | 1 | 2 | 3 | 4 |
|-----------------------|--------|--------|--------|--------|
| R _i (K/kW) | 3.498 | 0.899 | 0.540 | 0.064 |
| τ _i (s) | 0.4586 | 0.0559 | 0.0053 | 0.0010 |

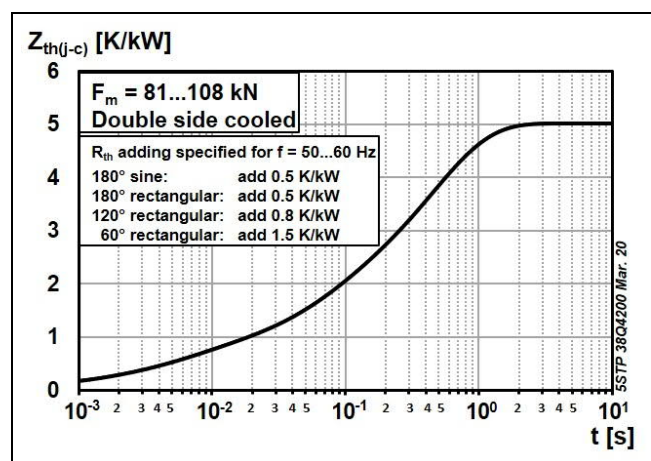

Fig. 1 Transient thermal impedance (junction-to-case) vs. time

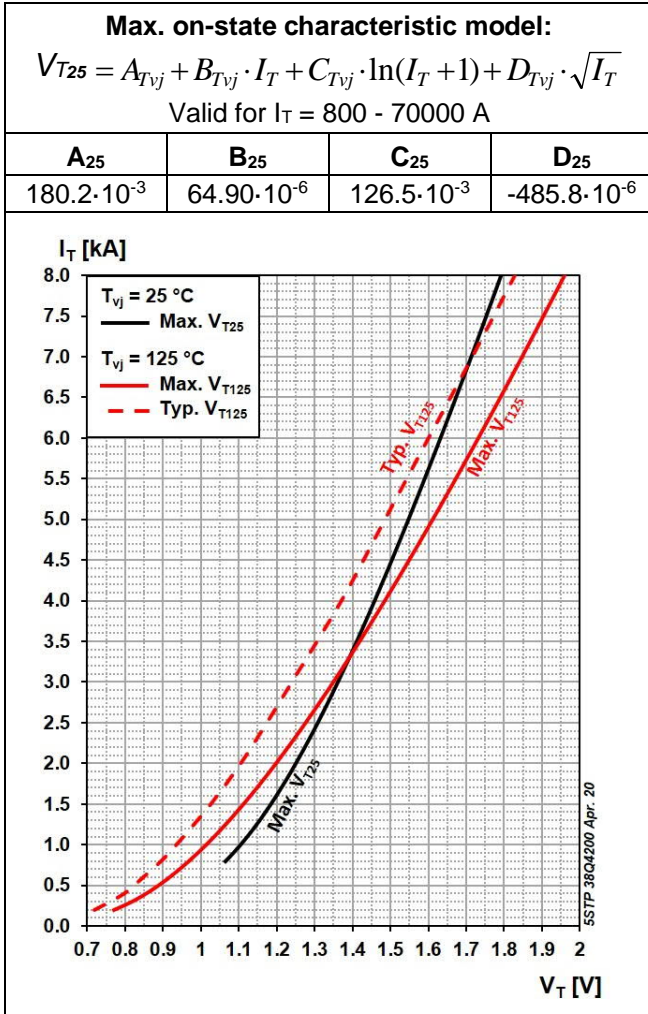

Fig. 2 On-state voltage characteristics

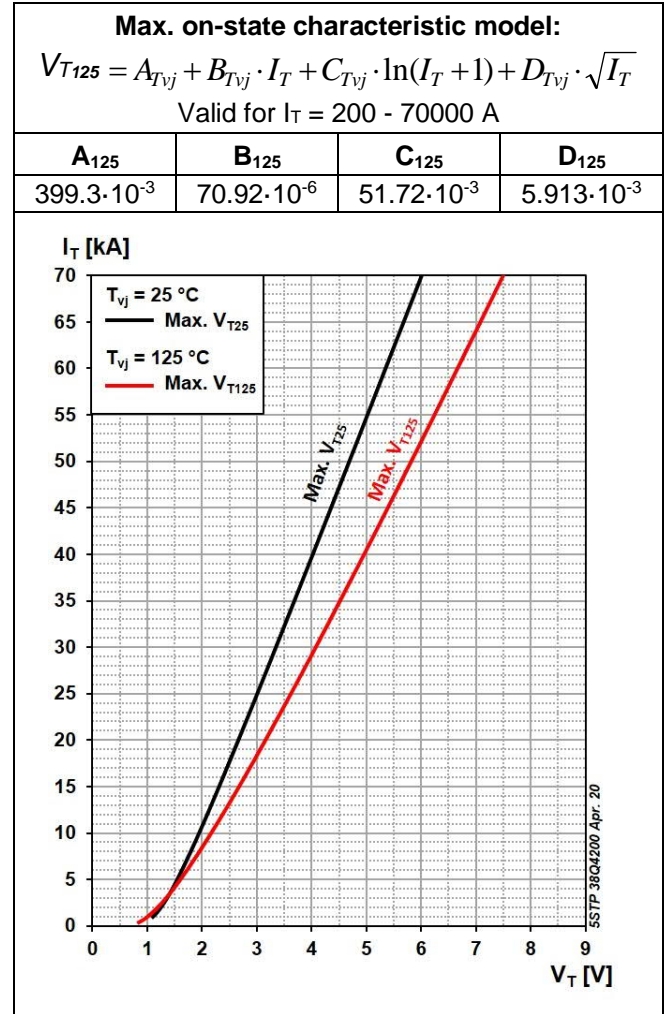

Fig. 3 On-state voltage characteristics

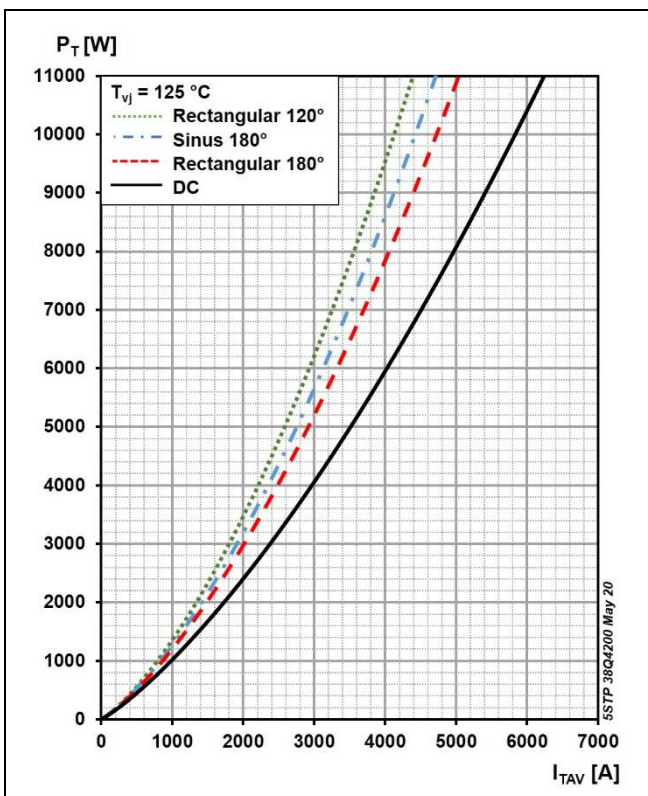

Fig. 4 On-state power dissipation vs. mean on-state current, turn-on losses excluded

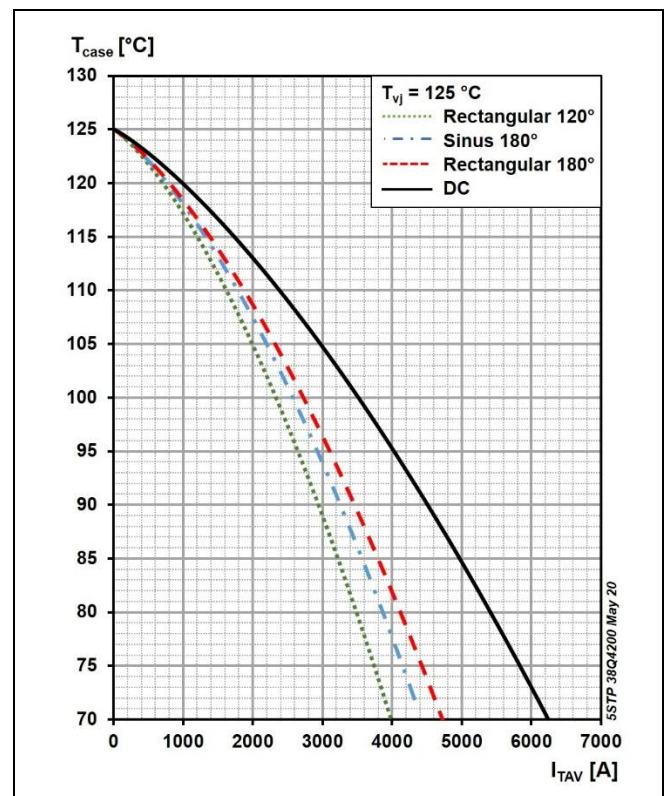

Fig. 5 Max. permissible case temperature vs. mean on-state current, switching losses ignored



Fig. 6 Recommended gate current waveform

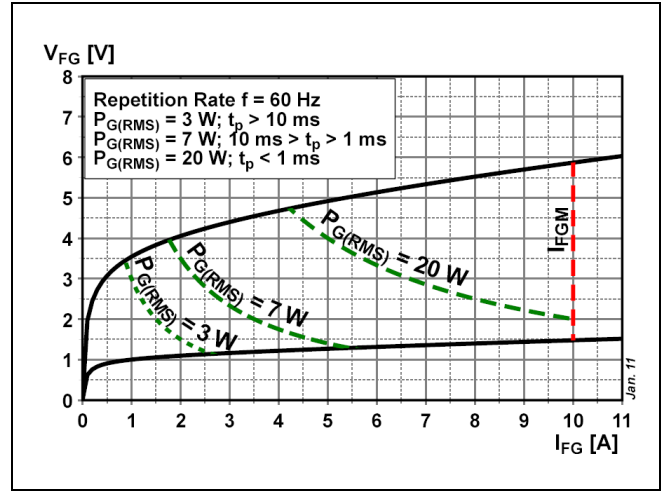

Fig. 7 Max. peak gate power loss

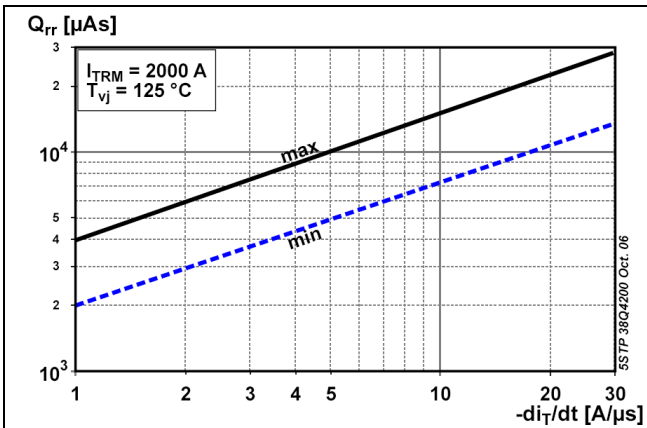

Fig. 8 Reverse recovery charge vs. decay rate of on-state current

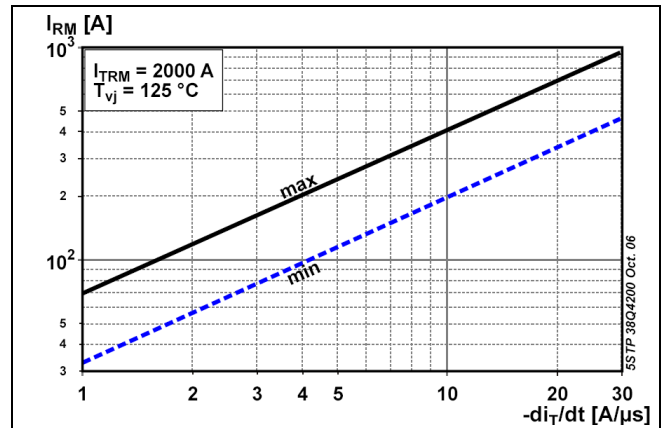

Fig. 9 Peak reverse recovery current vs. decay rate of on-state current

Turn-on and Turn-off losses

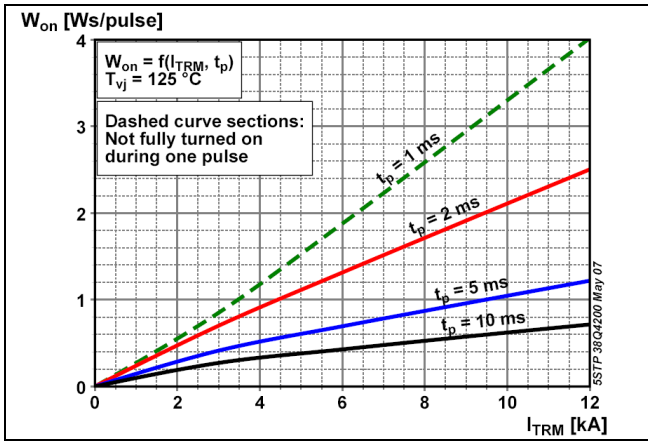

Fig. 10 Turn-on energy, half sinusoidal waves

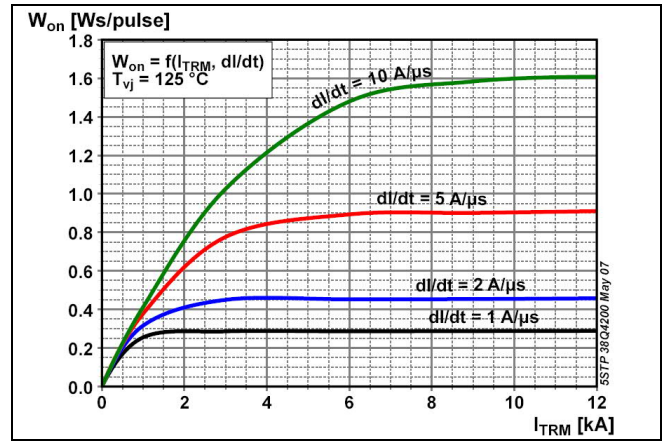

Fig. 11 Turn-on energy, rectangular waves

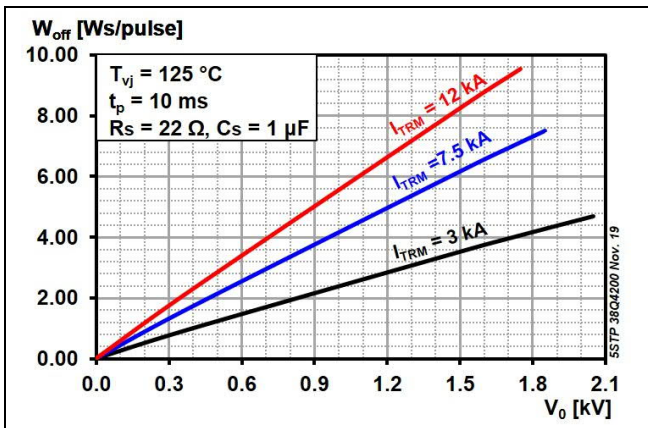

Fig. 12 Typical turn-off energy, half sinusoidal waves

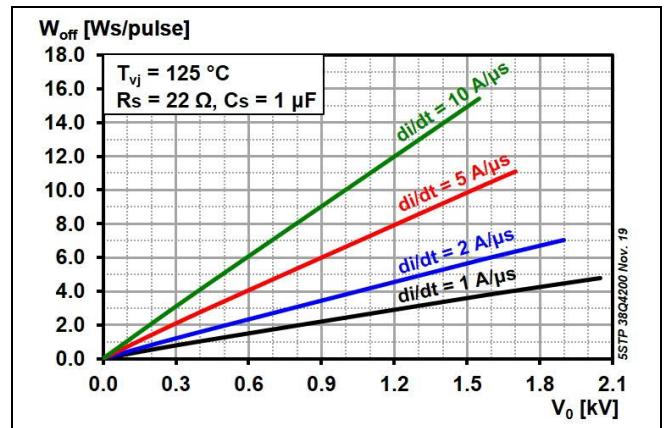

Fig. 13 Typical turn-off energy, rectangular waves

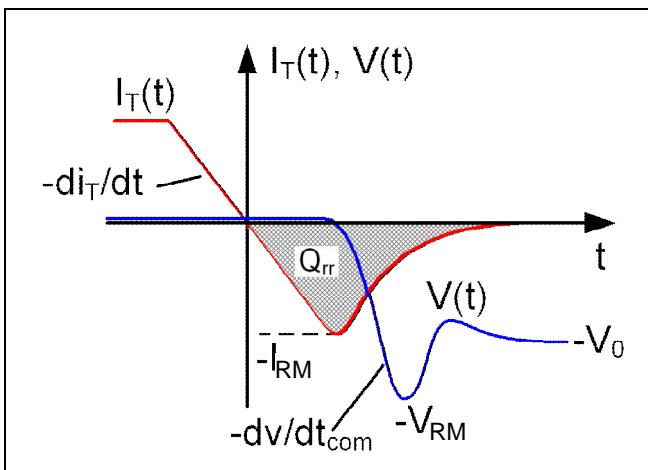

Fig. 14 Current and voltage waveforms at turn-off

Total power loss for repetitive waveforms:

$$P_{TOT} = P_T + W_{on} \cdot f + W_{off} \cdot f$$

where

$$P_T = \frac{1}{T} \int_0^T I_T \cdot V_T(I_T) dt$$

Fig. 15 Relationships for power loss

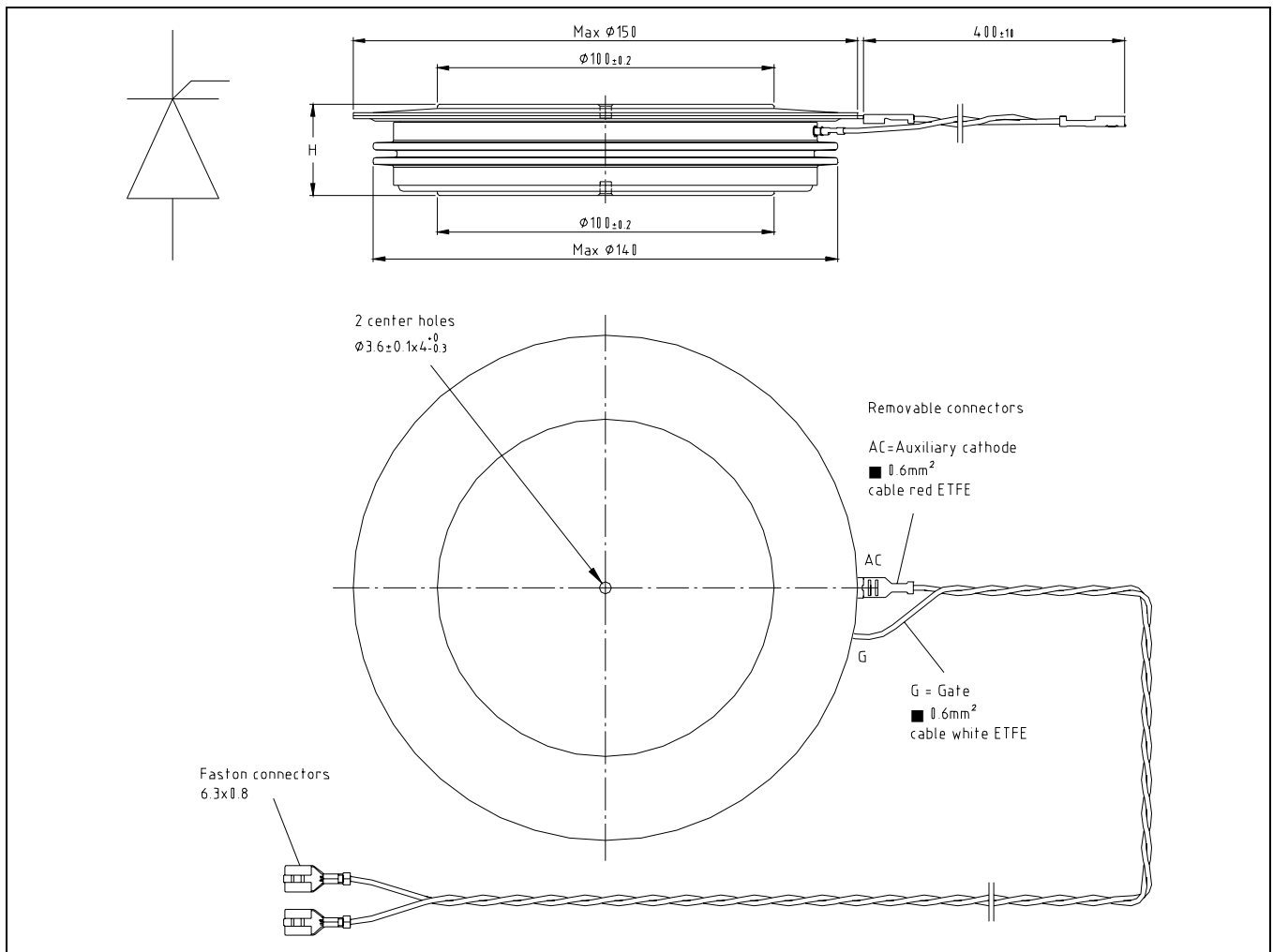

Fig. 16 Device Outline Drawing

Related documents:

| | |
|-----------|---|
| 5SYA 2020 | Design of RC-Snubbers for Phase Control Applications |
| 5SYA 2049 | Voltage definitions for phase control and bi-directionally controlled thyristors |
| 5SYA 2051 | Voltage ratings of high power semiconductors |
| 5SYA 2034 | Gate-drive recommendations for phase control and bi-directionally controlled thyristors |
| 5SYA 2036 | Recommendations regarding mechanical clamping of Press-Pack High Power Semiconductors |
| 5SYA 2102 | Surge currents for Phase Control Thyristors |
| 5SZK 9118 | General Environmental Conditions for High Power Semiconductors |

Please refer to <http://www.abb.com/semiconductors> for current version of documents.

ABB Power Grids Switzerland Ltd, Semiconductors reserves the right to change specifications without notice.



ABB Power Grids Switzerland Ltd
Semiconductors
 Fabrikstrasse 3
 CH-5600 Lenzburg, Switzerland

Doc. No. 5SYA1051-04 May. 20

Telephone +41 (0)58 586 1419
 Fax +41 (0)58 586 1306
 Email abbsem@ch.abb.com
 Internet www.abb.com/semiconductors