

## IHM-B module with fast Trench/Fieldstop IGBT3 and emitter controlled 3 diode

### Features

- Electrical features
  - $V_{CES} = 3300\text{ V}$
  - $I_{C\text{nom}} = 1200\text{ A} / I_{CRM} = 2400\text{ A}$
  - Unbeatable robustness
  - High DC stability
  - High short-circuit capability
  - Low switching losses
  - Low  $V_{CE,sat}$
  - $T_{vj,op} = 150^{\circ}\text{C}$
  - $V_{CE,sat}$  with positive temperature coefficient
- Mechanical features
  - AlSiC base plate for increased thermal cycling capability
  - Package with CTI > 600
  - IHM B housing
  - Isolated base plate



Typical appearance

### Potential applications

- Chopper applications
- Medium-voltage converters
- Motor drives
- Traction drives
- UPS systems
- Wind turbines

### Product validation

- Qualified for industrial applications according to the relevant tests of IEC 60747, 60749 and 60068

### Description

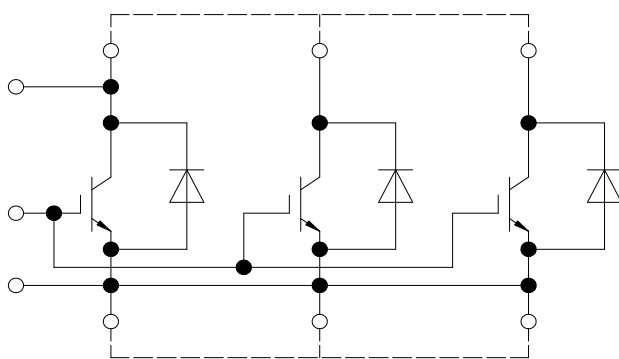

external connection  
(to be done)

## Table of contents

	<b>Description</b> .....	1
	<b>Features</b> .....	1
	<b>Potential applications</b> .....	1
	<b>Product validation</b> .....	1
	<b>Table of contents</b> .....	2
<b>1</b>	<b>Package</b> .....	3
<b>2</b>	<b>IGBT, Inverter</b> .....	3
<b>3</b>	<b>Diode, Inverter</b> .....	5
<b>4</b>	<b>Characteristics diagrams</b> .....	7
<b>5</b>	<b>Circuit diagram</b> .....	10
<b>6</b>	<b>Package outlines</b> .....	11
<b>7</b>	<b>Module label code</b> .....	12
	<b>Revision history</b> .....	13
	<b>Disclaimer</b> .....	14

## 1 Package

**Table 1** Insulation coordination

Parameter	Symbol	Note or test condition	Values	Unit
Isolation test voltage	$V_{ISOL}$	RMS, $f = 50$ Hz, $t = 1$ min	6.0	kV
Partial discharge extinction voltage	$V_{isol}$	RMS, $f = 50$ Hz, $Q_{PD} \leq 10$ pC	2.6	kV
DC stability	$V_{CE(D)}$	$T_{vj}=25^{\circ}\text{C}$ , 100 Fit	2100	V
Material of module baseplate			AlSiC	
Creepage distance	$d_{Creep}$	terminal to heatsink	32.2	mm
Clearance	$d_{Clear}$	terminal to heatsink	19.1	mm
Comparative tracking index	$CTI$		>600	

**Table 2** Characteristic values

Parameter	Symbol	Note or test condition	Values			Unit
			Min.	Typ.	Max.	
Stray inductance module	$L_{SCE}$			6		nH
Module lead resistance, terminals - chip	$R_{CC'+EE'}$	$T_C=25^{\circ}\text{C}$ , per switch		0.12		m $\Omega$
Storage temperature	$T_{stg}$		-40		150	$^{\circ}\text{C}$
Mounting torque for module mounting	$M$	- Mounting according to valid application note	M6, Screw	4.25	5.75	Nm
Terminal connection torque	$M$	- Mounting according to valid application note	M4, Screw	1.8	2.1	Nm
			M8, Screw	8	10	
Weight	$G$			1200		g

## 2 IGBT, Inverter

**Table 3** Maximum rated values

Parameter	Symbol	Note or test condition	Values	Unit	
Collector-emitter voltage	$V_{CES}$		$T_{vj} = -40^{\circ}\text{C}$	3300	V
			$T_{vj} = 150^{\circ}\text{C}$	3300	
Continuous DC collector current	$I_{CDC}$	$T_{vj\ max} = 150^{\circ}\text{C}$	$T_C = 95^{\circ}\text{C}$	1200	A
Repetitive peak collector current	$I_{CRM}$	$t_p = 1$ ms		2400	A
Gate-emitter peak voltage	$V_{GES}$			$\pm 20$	V

**Table 4** Characteristic values

Parameter	Symbol	Note or test condition	Values			Unit	
			Min.	Typ.	Max.		
Collector-emitter saturation voltage	$V_{CE\ sat}$	$I_C = 1200\ A, V_{GE} = 15\ V$	$T_{vj} = 25\ ^\circ C$		2.70	3.20	V
			$T_{vj} = 125\ ^\circ C$		3.15	3.60	
			$T_{vj} = 150\ ^\circ C$		3.30		
Gate threshold voltage	$V_{GEth}$	$I_C = 54\ mA, V_{CE} = V_{GE}, T_{vj} = 25\ ^\circ C$	5.20	5.80	6.40	V	
Gate charge	$Q_G$	$V_{GE} = \pm 15\ V, V_{CE} = 1800\ V$		32		$\mu C$	
Internal gate resistor	$R_{Gint}$	$T_{vj} = 25\ ^\circ C$		0.44		$\Omega$	
Input capacitance	$C_{ies}$	$f = 1000\ kHz, T_{vj} = 25\ ^\circ C, V_{CE} = 25\ V, V_{GE} = 0\ V$		210		nF	
Reverse transfer capacitance	$C_{res}$	$f = 1000\ kHz, T_{vj} = 25\ ^\circ C, V_{CE} = 25\ V, V_{GE} = 0\ V$		4.5		nF	
Collector-emitter cut-off current	$I_{CES}$	$V_{CE} = 3300\ V, V_{GE} = 0\ V$	$T_{vj} = 25\ ^\circ C$			5	mA
Gate-emitter leakage current	$I_{GES}$	$V_{CE} = 0\ V, V_{GE} = 20\ V, T_{vj} = 25\ ^\circ C$				400	nA
Turn-on delay time (inductive load)	$t_{don}$	$I_C = 1200\ A, V_{CE} = 1800\ V, V_{GE} = \pm 15\ V, R_{Gon} = 0.62\ \Omega, C_{GE} = 220\ nF$	$T_{vj} = 25\ ^\circ C$	0.350			$\mu s$
			$T_{vj} = 125\ ^\circ C$	0.380			
			$T_{vj} = 150\ ^\circ C$	0.380			
Rise time (inductive load)	$t_r$	$I_C = 1200\ A, V_{CE} = 1800\ V, V_{GE} = \pm 15\ V, R_{Gon} = 0.62\ \Omega, C_{GE} = 220\ nF$	$T_{vj} = 25\ ^\circ C$	0.350			$\mu s$
			$T_{vj} = 125\ ^\circ C$	0.380			
			$T_{vj} = 150\ ^\circ C$	0.380			
Turn-off delay time (inductive load)	$t_{doff}$	$I_C = 1200\ A, V_{CE} = 1800\ V, V_{GE} = \pm 15\ V, R_{Goff} = 2.4\ \Omega, C_{GE} = 220\ nF$	$T_{vj} = 25\ ^\circ C$	3.000			$\mu s$
			$T_{vj} = 125\ ^\circ C$	3.200			
			$T_{vj} = 150\ ^\circ C$	3.200			
Fall time (inductive load)	$t_f$	$I_C = 1200\ A, V_{CE} = 1800\ V, V_{GE} = \pm 15\ V, R_{Goff} = 2.4\ \Omega, C_{GE} = 220\ nF$	$T_{vj} = 25\ ^\circ C$	0.300			$\mu s$
			$T_{vj} = 125\ ^\circ C$	0.350			
			$T_{vj} = 150\ ^\circ C$	0.350			
Turn-on time (resistive load)	$t_{on\_R}$	$I_C = 500\ A, V_{CE} = 2000\ V, V_{GE} = \pm 15\ V, R_{Gon} = 0.62\ \Omega, C_{GE} = 220\ nF$	$T_{vj} = 25\ ^\circ C$	1.11			$\mu s$
Turn-on energy loss per pulse	$E_{on}$	$I_C = 1200\ A, V_{CE} = 1800\ V, L_\sigma = 85\ nH, V_{GE} = \pm 15\ V, R_{Gon} = 0.62\ \Omega, C_{GE} = 220\ nF, di/dt = 4300\ A/\mu s (T_{vj} = 150\ ^\circ C)$	$T_{vj} = 25\ ^\circ C$	1400			mJ
			$T_{vj} = 125\ ^\circ C$	1950			
			$T_{vj} = 150\ ^\circ C$	2200			

(table continues...)

**Table 4 (continued) Characteristic values**

Parameter	Symbol	Note or test condition	Values			Unit
			Min.	Typ.	Max.	
Turn-off energy loss per pulse	$E_{off}$	$I_C = 1200\text{ A}$ , $V_{CE} = 1800\text{ V}$ , $L_\sigma = 85\text{ nH}$ , $V_{GE} = \pm 15\text{ V}$ , $R_{Goff} = 2.4\ \Omega$ , $C_{GE} = 220\text{ nF}$ , $dv/dt = 2100\text{ V}/\mu\text{s}$ ( $T_{vj} = 150\text{ }^\circ\text{C}$ )	$T_{vj} = 25\text{ }^\circ\text{C}$	1350		mJ
			$T_{vj} = 125\text{ }^\circ\text{C}$	1800		
			$T_{vj} = 150\text{ }^\circ\text{C}$	1950		
SC data	$I_{SC}$	$V_{GE} \leq 15\text{ V}$ , $V_{CC} = 2500\text{ V}$ , $V_{CEmax} = V_{CES} - L_{sCE} \cdot di/dt$	$t_p \leq 10\ \mu\text{s}$ , $T_{vj} = 150\text{ }^\circ\text{C}$	4800		A
Thermal resistance, junction to case	$R_{thJC}$	per IGBT			9.55	K/kW
Thermal resistance, case to heat sink	$R_{thCH}$	per IGBT, $\lambda_{grease} = 1\text{ W}/(\text{m}^2\text{K})$		10.0		K/kW
Temperature under switching conditions	$T_{vj\text{ op}}$		-40		150	$^\circ\text{C}$

### 3 Diode, Inverter

**Table 5 Maximum rated values**

Parameter	Symbol	Note or test condition	Values	Unit	
Repetitive peak reverse voltage	$V_{RRM}$		$T_{vj} = -40\text{ }^\circ\text{C}$	3300	V
			$T_{vj} = 150\text{ }^\circ\text{C}$	3300	
Continuous DC forward current	$I_F$		1200	A	
Repetitive peak forward current	$I_{FRM}$	$t_p = 1\text{ ms}$	2400	A	
$I^2t$ - value	$I^2t$	$t_p = 10\text{ ms}$ , $V_R = 0\text{ V}$	$T_{vj} = 125\text{ }^\circ\text{C}$	330	kA <sup>2</sup> s
			$T_{vj} = 150\text{ }^\circ\text{C}$	310	
Maximum power dissipation	$P_{RQM}$	$T_{vj} = 150\text{ }^\circ\text{C}$	1800	kW	
Minimum turn-on time	$t_{onmin}$		10	$\mu\text{s}$	

**Table 6 Characteristic values**

Parameter	Symbol	Note or test condition	Values			Unit
			Min.	Typ.	Max.	
Forward voltage	$V_F$	$I_F = 1200\text{ A}$ , $V_{GE} = 0\text{ V}$	$T_{vj} = 25\text{ }^\circ\text{C}$	3.25	3.95	V
			$T_{vj} = 125\text{ }^\circ\text{C}$	2.90	3.35	
			$T_{vj} = 150\text{ }^\circ\text{C}$	2.80		

(table continues...)

**Table 6 (continued) Characteristic values**

Parameter	Symbol	Note or test condition	Values			Unit
			Min.	Typ.	Max.	
Peak reverse recovery current	$I_{RM}$	$V_R = 1800\text{ V}$ , $I_F = 1200\text{ A}$ , $V_{GE} = -15\text{ V}$ , $-di_F/dt = 4300\text{ A}/\mu\text{s}$ ( $T_{vj} = 150\text{ }^\circ\text{C}$ )	$T_{vj} = 25\text{ }^\circ\text{C}$	1250		A
			$T_{vj} = 125\text{ }^\circ\text{C}$	1400		
			$T_{vj} = 150\text{ }^\circ\text{C}$	1450		
Recovered charge	$Q_r$	$V_R = 1800\text{ V}$ , $I_F = 1200\text{ A}$ , $V_{GE} = -15\text{ V}$ , $-di_F/dt = 4300\text{ A}/\mu\text{s}$ ( $T_{vj} = 150\text{ }^\circ\text{C}$ )	$T_{vj} = 25\text{ }^\circ\text{C}$	550		$\mu\text{C}$
			$T_{vj} = 125\text{ }^\circ\text{C}$	1100		
			$T_{vj} = 150\text{ }^\circ\text{C}$	1300		
Reverse recovery energy	$E_{rec}$	$V_R = 1800\text{ V}$ , $I_F = 1200\text{ A}$ , $V_{GE} = -15\text{ V}$ , $-di_F/dt = 4300\text{ A}/\mu\text{s}$ ( $T_{vj} = 150\text{ }^\circ\text{C}$ )	$T_{vj} = 25\text{ }^\circ\text{C}$	550		mJ
			$T_{vj} = 125\text{ }^\circ\text{C}$	1250		
			$T_{vj} = 150\text{ }^\circ\text{C}$	1500		
Thermal resistance, junction to case	$R_{thJC}$	per diode			17.0	K/kW
Thermal resistance, case to heat sink	$R_{thCH}$	per diode, $\lambda_{grease} = 1\text{ W}/(\text{m}^*\text{K})$		11.5		K/kW
Temperature under switching conditions	$T_{vj\text{ op}}$		-40		150	$^\circ\text{C}$

## 4 Characteristics diagrams

### output characteristic (typical), IGBT, Inverter

$$I_C = f(V_{CE})$$

$$V_{GE} = 15 \text{ V}$$

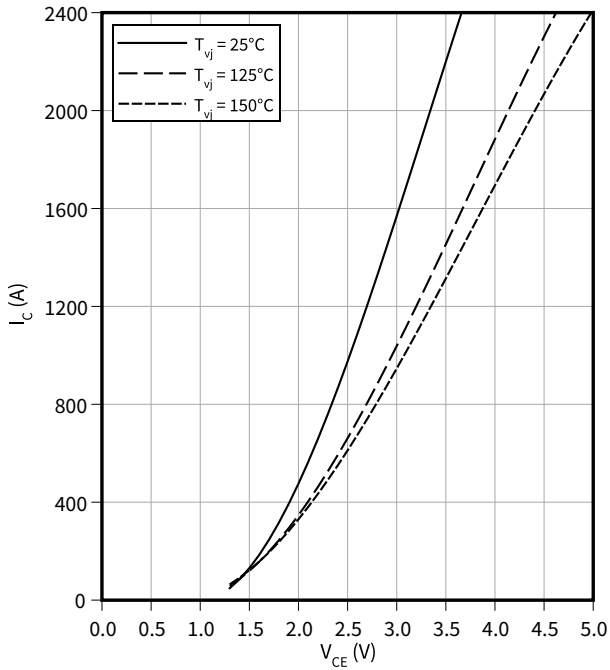

### output characteristic (typical), IGBT, Inverter

$$I_C = f(V_{CE})$$

$$T_{vj} = 150 \text{ °C}$$

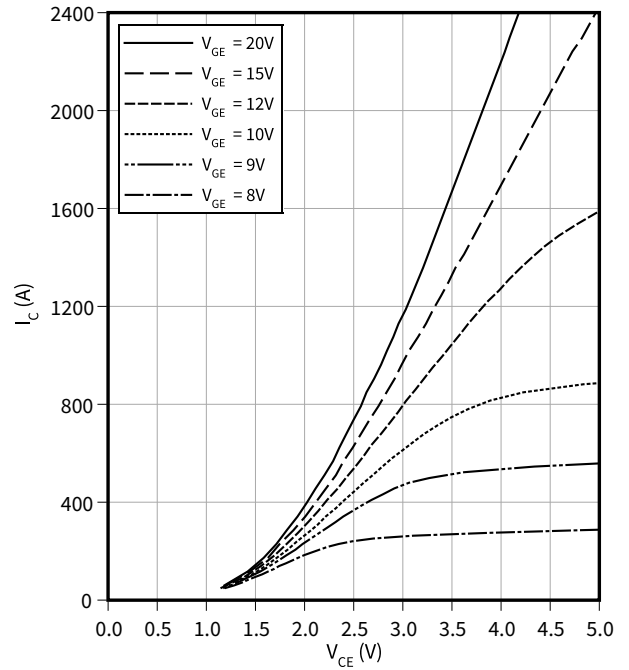

### transfer characteristic (typical), IGBT, Inverter

$$I_C = f(V_{GE})$$

$$V_{CE} = 20 \text{ V}$$

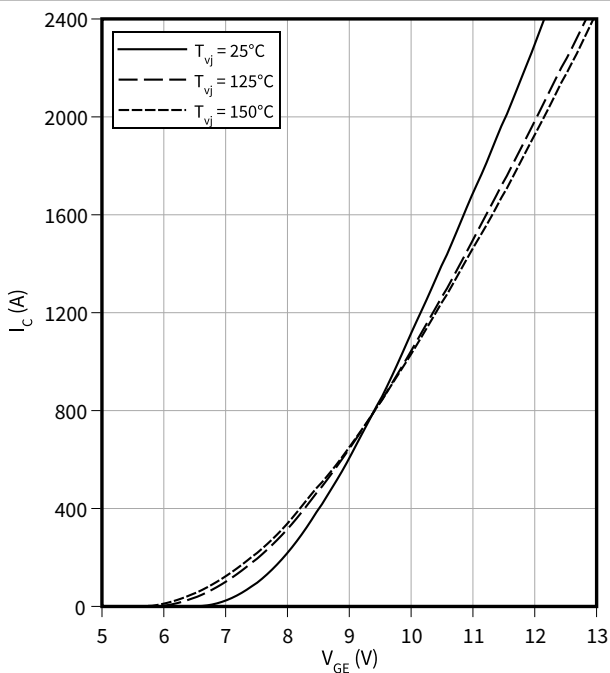

### switching losses (typical), IGBT, Inverter

$$E = f(I_C)$$

$$R_{Goff} = 2.4 \text{ } \Omega, R_{Gon} = 0.62 \text{ } \Omega, C_{GE} = 220 \text{ nF}, V_{CE} = 1800 \text{ V}, V_{GE} = -15 / 15 \text{ V}$$

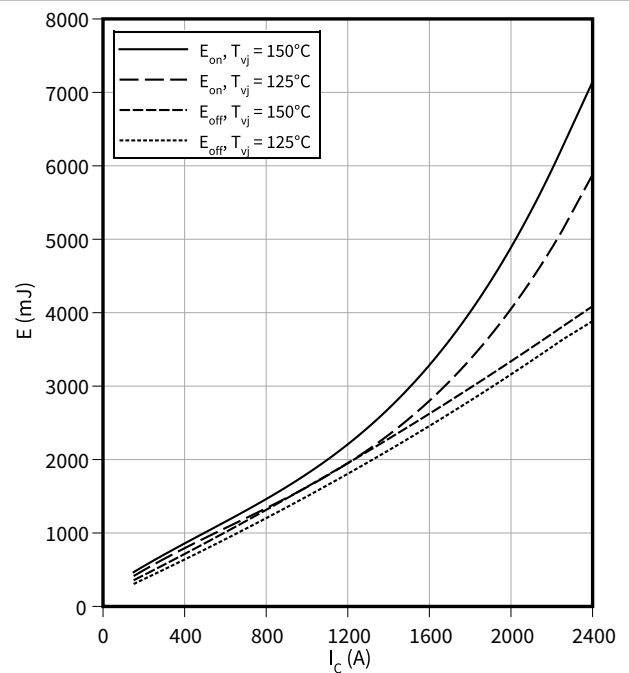

4 Characteristics diagrams

**switching losses (typical), IGBT, Inverter**

$E = f(R_G)$

$I_C = 1200 \text{ A}$ ,  $C_{GE} = 220 \text{ nF}$ ,  $V_{CE} = 1800 \text{ V}$ ,  $V_{GE} = -15 / 15 \text{ V}$

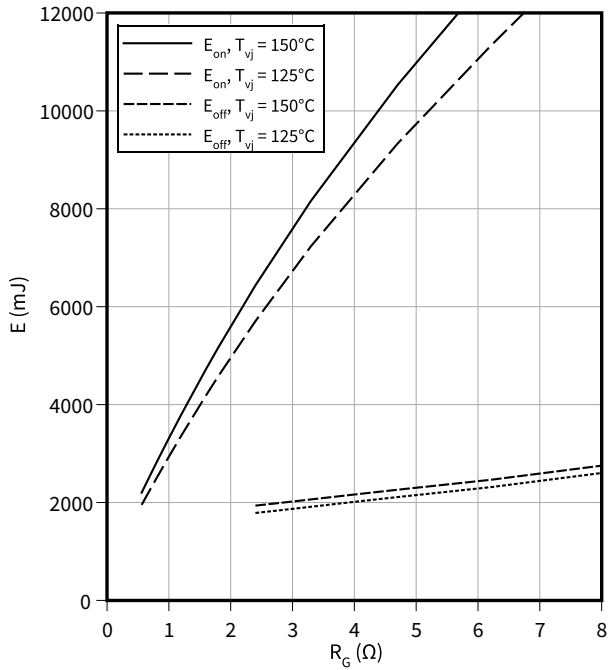

**transient thermal impedance, IGBT, Inverter**

$Z_{th} = f(t)$

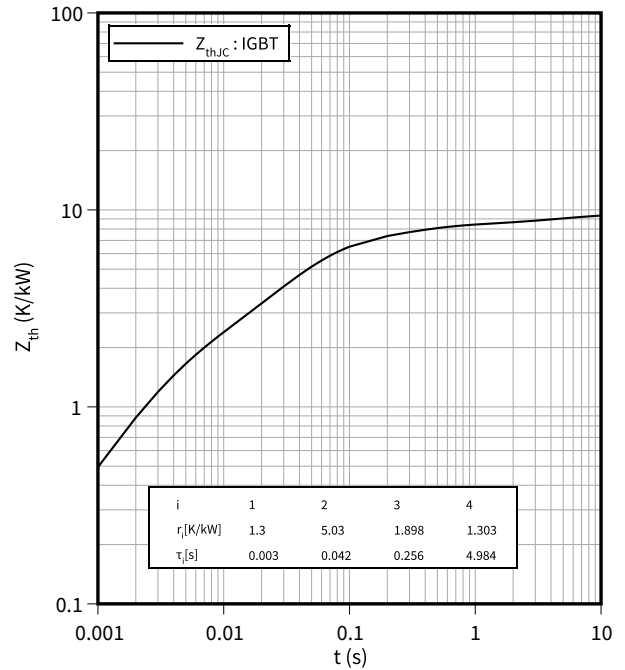

**reverse bias safe operating area (RBSOA), IGBT, Inverter**

$I_C = f(V_{CE})$

$R_{Goff} = 2.4 \Omega$ ,  $V_{GE} = \pm 15 \text{ V}$ ,  $C_{GE} = 220 \text{ nF}$ ,  $T_{vj} = 150 \text{ °C}$

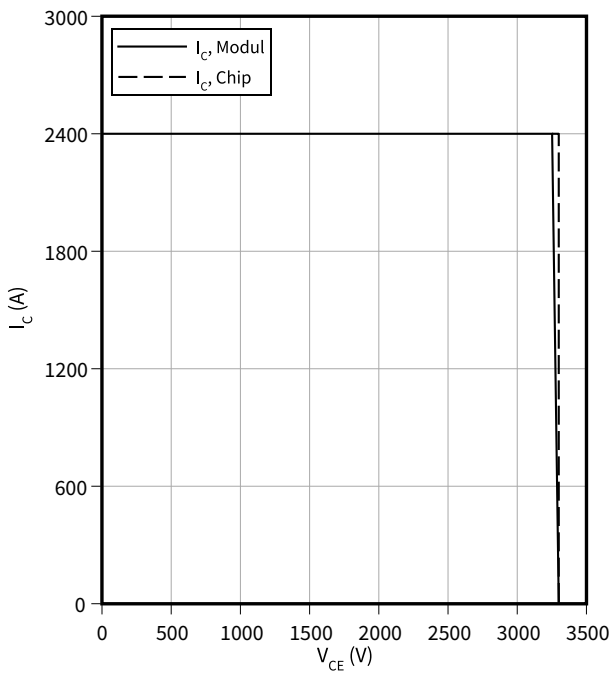

**forward characteristic (typical), Diode, Inverter**

$I_F = f(V_F)$

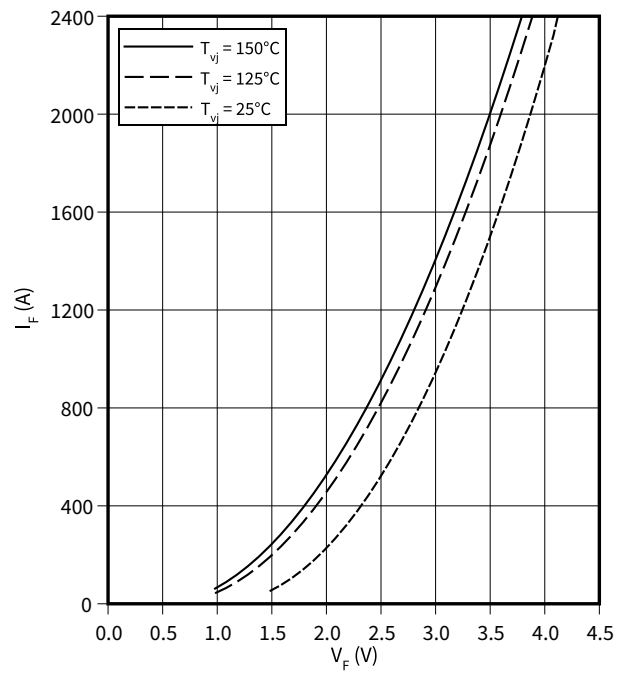



4 Characteristics diagrams

**switching losses (typical), Diode, Inverter**

$E_{rec} = f(I_F)$

$V_{CE} = 1800\text{ V}, R_{Gon} = R_{Gon}(IGBT)$

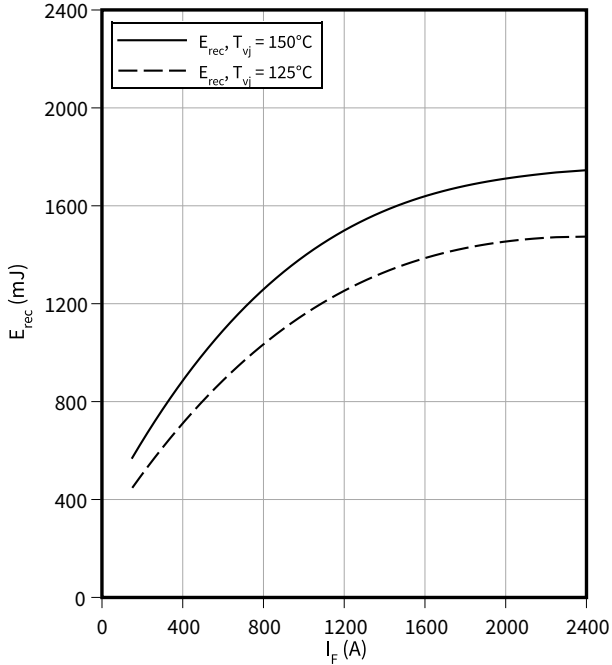

**switching losses (typical), Diode, Inverter**

$E_{rec} = f(R_G)$

$V_{CE} = 1800\text{ V}, I_F = 1200\text{ A}$

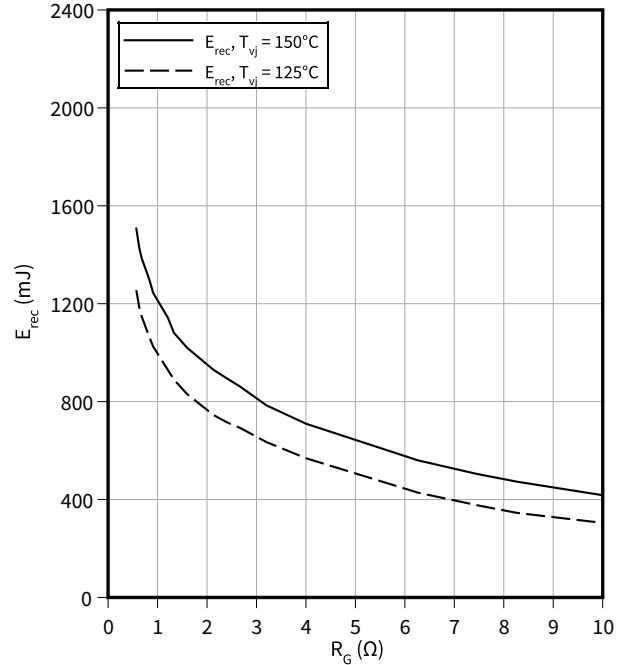

**transient thermal impedance , Diode, Inverter**

$Z_{th} = f(t)$

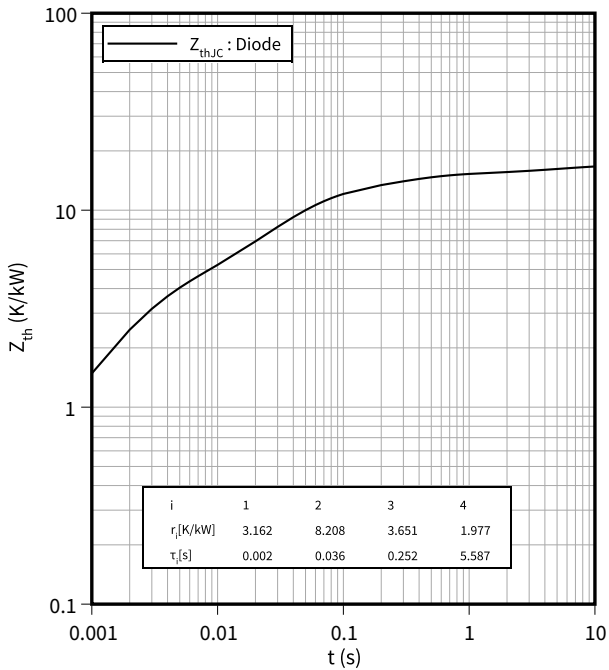

**safe operation area (SOA), Diode, Inverter**

$I_R = f(V_R)$

$T_{vj} = 150\text{ °C}$

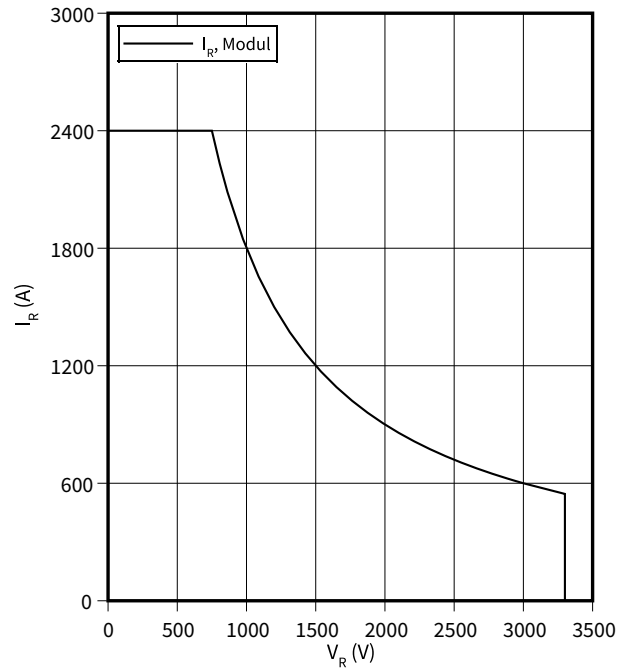

## 5 Circuit diagram

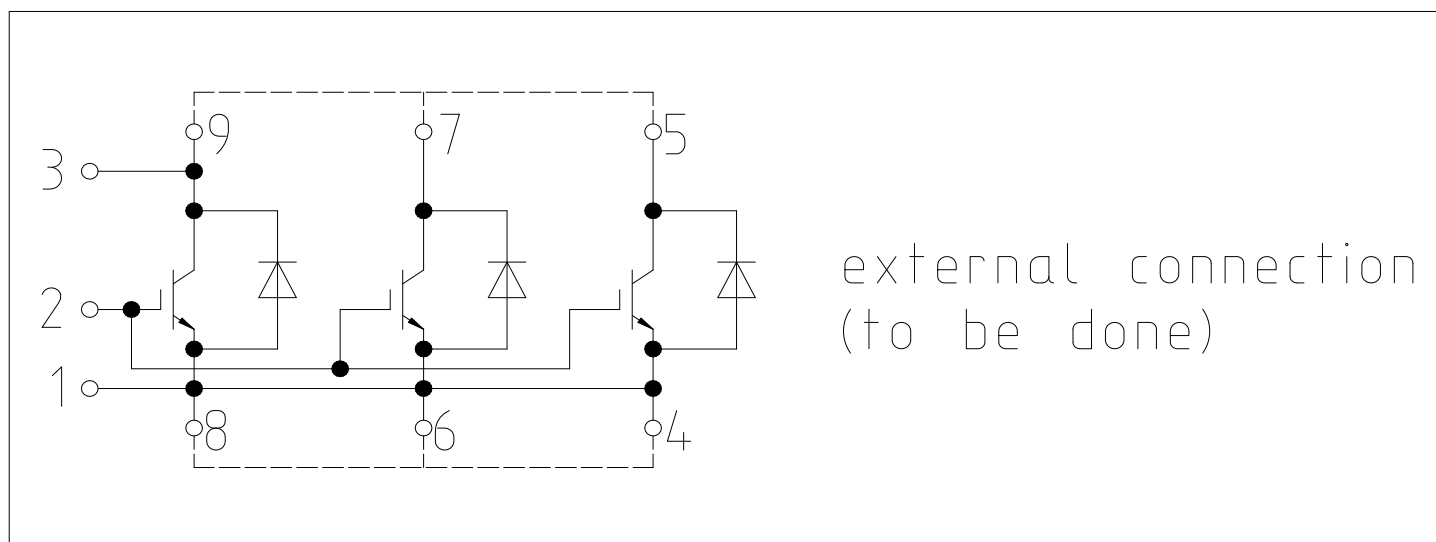

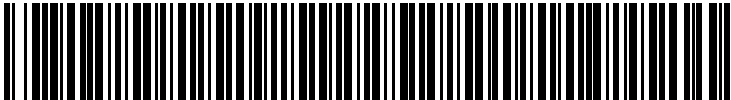

Figure 1



## 7 Module label code

Module label code			
Code format	Data Matrix	Barcode Code128	
Encoding	ASCII text	Code Set A	
Symbol size	16x16	23 digits	
Standard	IEC24720 and IEC16022	IEC8859-1	
Code content	<i>Content</i>	<i>Digit</i>	<i>Example</i>
	Module serial number	1 - 5	71549
	Module material number	6 - 11	142846
	Production order number	12 - 19	55054991
	Date code (production year)	20 - 21	15
	Date code (production week)	22 - 23	30
Example	 		
	71549142846550549911530		71549142846550549911530

**Figure 3**

## Revision history

Document revision	Date of release	Description of changes
V1.0	2009-09-15	Target datasheet
V2.0	2010-04-26	Preliminary datasheet
V2.1	2010-07-16	Preliminary datasheet
V3.0	2013-08-12	Final datasheet
V3.1	2013-12-11	Final datasheet
V3.2	2018-07-12	Final datasheet
V3.3	2019-07-24	Final datasheet
n/a	2020-09-01	Datasheet migrated to a new system with a new layout and new revision number schema: target or preliminary datasheet = 0.xy; final datasheet = 1.xy
1.10	2021-10-29	Final datasheet

## Trademarks

All referenced product or service names and trademarks are the property of their respective owners.

**Edition 2021-10-29**

**Published by**

**Infineon Technologies AG**

**81726 Munich, Germany**

**© 2021 Infineon Technologies AG**

**All Rights Reserved.**

**Do you have a question about any aspect of this document?**

**Email: [erratum@infineon.com](mailto:erratum@infineon.com)**

**Document reference**

**IFX-AAW134-008**

## IMPORTANT NOTICE

The information given in this document shall in no event be regarded as a guarantee of conditions or characteristics ("Beschaffenhheitsgarantie").

With respect to any examples, hints or any typical values stated herein and/or any information regarding the application of the product, Infineon Technologies hereby disclaims any and all warranties and liabilities of any kind, including without limitation warranties of non-infringement of intellectual property rights of any third party.

In addition, any information given in this document is subject to customer's compliance with its obligations stated in this document and any applicable legal requirements, norms and standards concerning customer's products and any use of the product of Infineon Technologies in customer's applications.

The data contained in this document is exclusively intended for technically trained staff. It is the responsibility of customer's technical departments to evaluate the suitability of the product for the intended application and the completeness of the product information given in this document with respect to such application.

## WARNINGS

Due to technical requirements products may contain dangerous substances. For information on the types in question please contact your nearest Infineon Technologies office.

Except as otherwise explicitly approved by Infineon Technologies in a written document signed by authorized representatives of Infineon Technologies, Infineon Technologies' products may not be used in any applications where a failure of the product or any consequences of the use thereof can reasonably be expected to result in personal injury.